

# VW AMAROK (2023+) & FORD RANGER (2023+)

## ROOF POD KIT INSTRUCTIONS



## WHAT'S REQUIRED

- Roof Pod (2x Glide pre-mounted)
- Positioning Templates (LH/RH)
- VHB Cleaning Sachet (x5)
- Black Dow Corning (1x Tube)
- One-Lamp Wiring Kit + Y-Splitter
- 12V Power Relay
- Cable Grommet (x1)
- Heat Shrink Butt Connector (x2)
- 1.2m Wire Concealer

Also required (not included in kit):

- Cable Ties
- Masking Tape
- Loom Tape
- Crimps

## TOOLS REQUIRED

- Socket Set
- Ratchet
- Pick set
- T20 Torx
- Drill
- Half inch drill bit
- Pilot drill bit (3-4mm)
- Wire cutters
- Wire strippers
- Heat source
- Plastic trim removal tools
- Work knife
- Sharpie
- Measuring tape
- Glue gun
- Square file



### IMPORTANT:

Keep the vehicle parked for a minimum of 24 hours after installation, so the pods have time to bond securely to the roof.

### DIFFICULTY

NO DRILL  
(3/5) 

ROOF DRILL  
(5/5) 

### INSTALLATION TIME

NO DRILL: **2 HOURS**  
ROOF DRILL: **3 HOURS**

## WIRING: ROOF DRILL SOLUTION

The steps below (1–18) are intended for customers installing the roof pod wiring by drilling through the roof. If you are using the A-pillar wire concealer, please refer to the next wiring section (page 7).



### STEP 1

Disconnect the vehicle's battery negative terminal and rest on a cloth or other insulator.



## STEP 2

Remove the left hand A-pillar grab handle (2x 7mm bolts).



## STEP 3

Remove the left hand A-pillar trim.



## STEP 4

Un-plug tweeter on the Harmon/Kardon or Bang & Olufsen equipped vehicles.



## STEP 5

Remove the left hand sun visor, making sure to unplug the light and not break the visor or connector (2x T20 screws on the visor hinge, 1x T20 screw in the clip).





## STEP 6

Using a trim tool, release the central roof console.



## STEP 7

Release the electrical connections and remove the roof console out of the way completely.



## STEP 8

Remove the 2x T20 screws holding up the vehicle headlining to the roof.



## STEP 9

Remove the left hand sill cover for access.



### STEP 8

Mount the relay holder in suitable place within the engine bay.

Then, clip in the relay base.

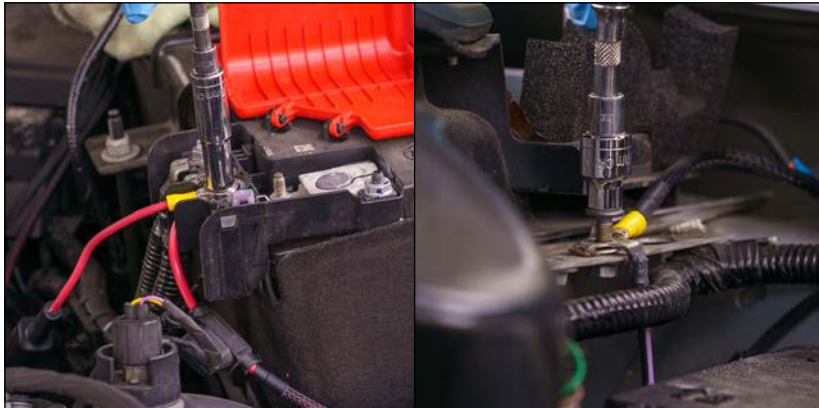

### STEP 9

Connect up positive and negative leads from the relay.



### STEP 10

Remove the connector from the supplied Lazer harness, and discard.

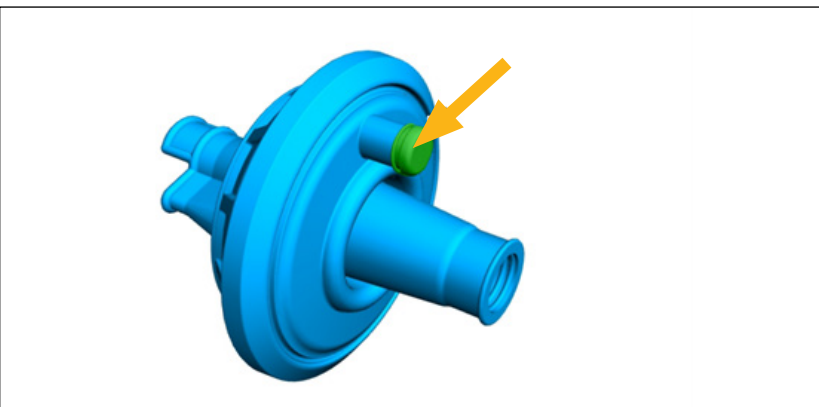

### STEP 11

Pass the positive, negative and trigger wire through the firewall into vehicle interior.

Ford/VW have provided an accessory port in the grommet for applications like this.





## STEP 12

With the wire inside, run it up the A-pillar and along the roof to the roof console opening, securing to existing wiring with cable ties where possible.

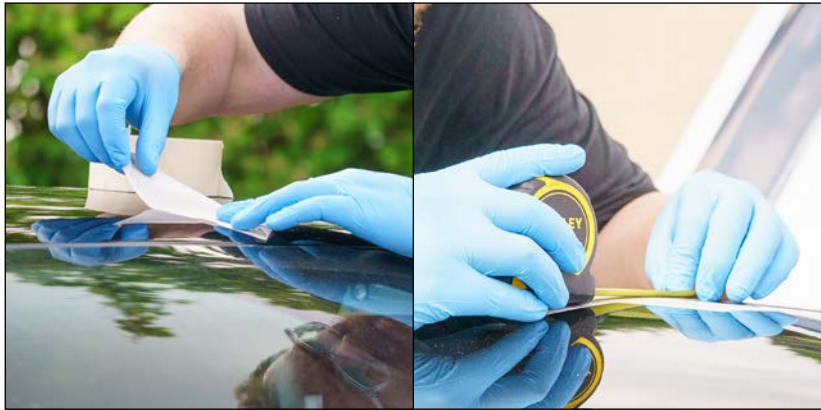

## STEP 13

Tape up the roof where you will be drilling. Use the ADAS camera as your centre point, and 85mm back from the front of the roof.



## STEP 14

Drill through the roof with a 1/2 inch drill bit and debur the edges once through. Make sure to cover any interior/exterior components which may get swarf on.



## STEP 15

Apply supplied grease to roof hole and rubber grommet.



### STEP 16

Fit grommet to the roof, ensuring the roof skin is in the ridge all the way around on the inside to make a complete seal.



### STEP 17

Using a 3mm drill bit or similar, break the seal in the grommet to allow the lamp wires to be passed through.



### STEP 18

Using cloths to protect the roof and pod, start to pass the pod wires through the roof grommet.

Use left over grease to lubricate and help seal against water ingress. This will be very tight.



## WIRING: NO-DRILL SOLUTION

The steps below (1–12) are intended for customers installing the roof pod wiring by using the A-pillar wire concealer.



### STEP 1

Disconnect the vehicle's battery negative terminal and rest on a cloth or other insulator.



### STEP 2

Mount the relay holder in suitable place within the engine bay.

Then, clip in the relay base.



### STEP 3

Pass lamp wiring out of the engine bay via a gap between the scuttle panel and the windscreen.



### STEP 4

Run wire up the windscreen and halfway across the roof. Cut the wire down to this length.



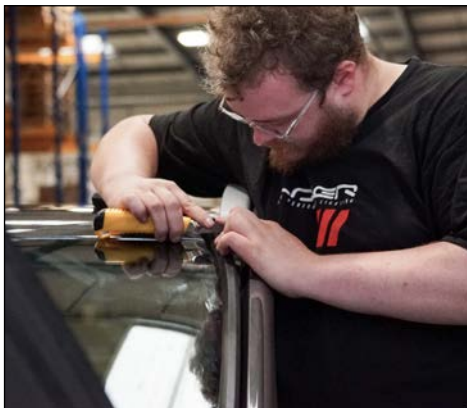

## STEP 5

Place rubber wire hider on the windshield and trim to the correct length.



## STEP 6

Prepare the windshield for bonding with one of the supplied 3M wipes

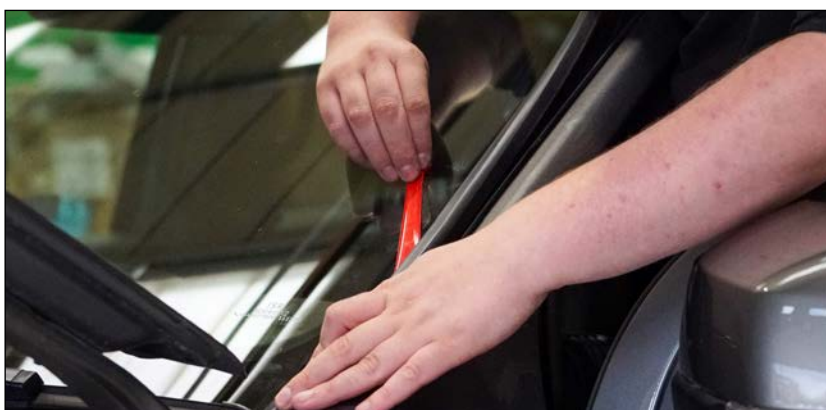

## STEP 7

Remove the red backing to stick down the rubber trim.

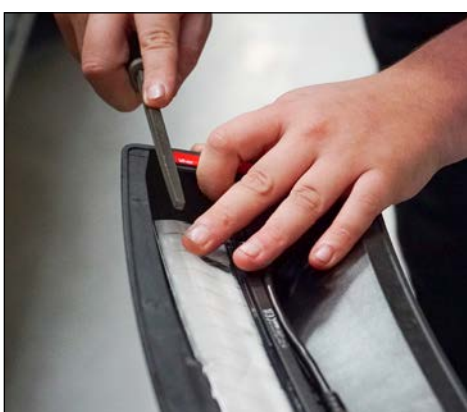

## STEP 8

Place roof pod on something solid. Use a file to create a notch in the side to allow for the cable to pass under.



### STEP 9

Strip back wires on the pod and the vehicle side wiring loom.

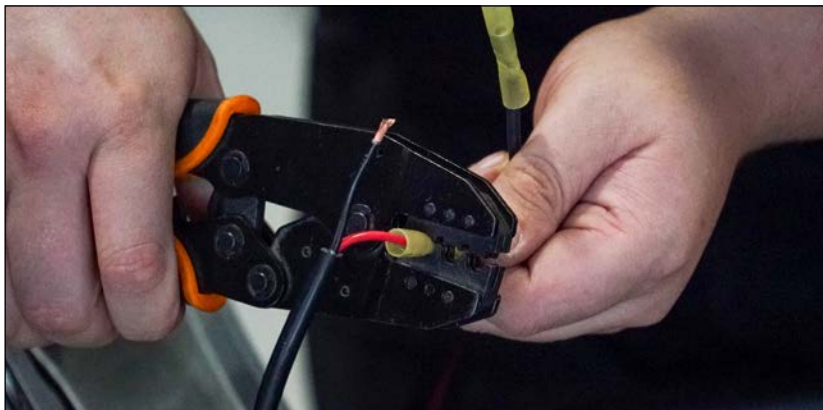

### STEP 10

Crimp together wires from the pod to the vehicle side harness.



### STEP 11

This connection is in a wet area so it is important to seal the crimps with a heat gun/ gas soldering iron to prevent water ingress.



### STEP 12

Secure the loom in the pod.



## POD INSTALLATION



### STEP 1

Clean the roof with the supplied 3m cleaning wipes and apply the positioning guides to the roof.

(Final production versions may differ from the image).



### STEP 2

Clean the pod with the supplied 3m cleaning wipes and apply glue to the pod in the 4 glue channels.

Note – please check use by date on the glue before application.



### STEP 3

Remove red backing from the pre-applied VHB tape.

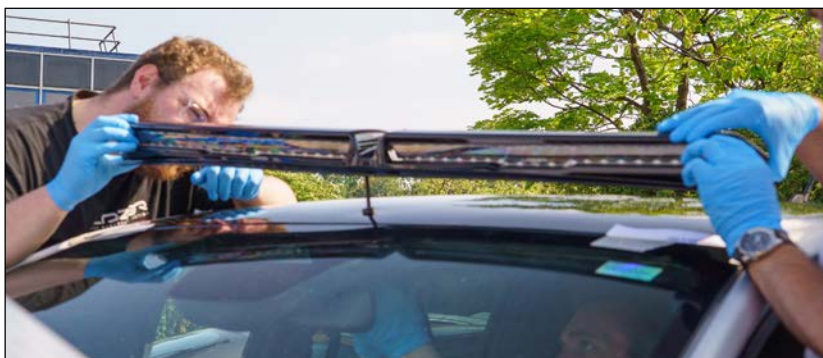

### STEP 4

With help from another person, place the pod on the roof in the area shown by the positioning guides.

You may also need a third person to pull the cable through the roof grommet from the inside.



### STEP 5

Press down on the pod in the 4 areas where there was VHB tape applied for it to grab.

Applying weights or tape while the adhesive sets will help give the best bond.

## WIRING CONTINUED: ROOF DRILL SOLUTION

The steps below (1–5) are intended for customers installing the roof pod wiring by drilling through the roof. If you are using the A-pillar wire concealer, please refer to the next wiring section (page 12).



### STEP 1

Strip back the insulation from the roof pod, and added power harness.



### STEP 2

Using supplied yellow crimps, join the roof pod and power harness together.



### STEP 3

For vehicles with overhead switches – locate wire spurs for Aux switches 1,2 & 5.

We are using Aux 5 on this vehicle to activate the pod – Green/Brown wire.





#### STEP 4

Connect the relay trigger wire to the Green/Brown or Aux switch wire of your choice.

If using CANNY on the vehicle, this wire can be ran to the CANNY harness.

If the vehicle has Halogen or the lower spec LED headlights, run the trigger wire to the Grey/Brown 12v high beam wire.



#### STEP 5

Re-connect the battery, test the lights and tidy wiring.

#### IMPORTANT!

Keep the vehicle parked for a minimum of 24 hours after installation, so the pods have time to bond securely to the roof.

## WIRING CONTINUED: NO-DRILL SOLUTION

The steps below (1–6) are intended for customers installing the roof pod wiring by using the A-pillar wire concealer.



### STEP 1

Tuck lamp harness into the wire hider trim down the length of the windshield.



### STEP 2

For vehicles with overhead switches – locate wire spurs for Aux switches 1,2 & 5.

We are using Aux 5 on this vehicle to activate the pod – Green/Brown wire.



### STEP 3

Connect the relay trigger wire to the Green/Brown or Aux switch wire of your choice.

If using CANNY on the vehicle, this wire can be ran to the CANNY harness.

If the vehicle has Halogen or the lower spec LED headlights, run the trigger wire to the Grey/Brown 12v high beam wire.



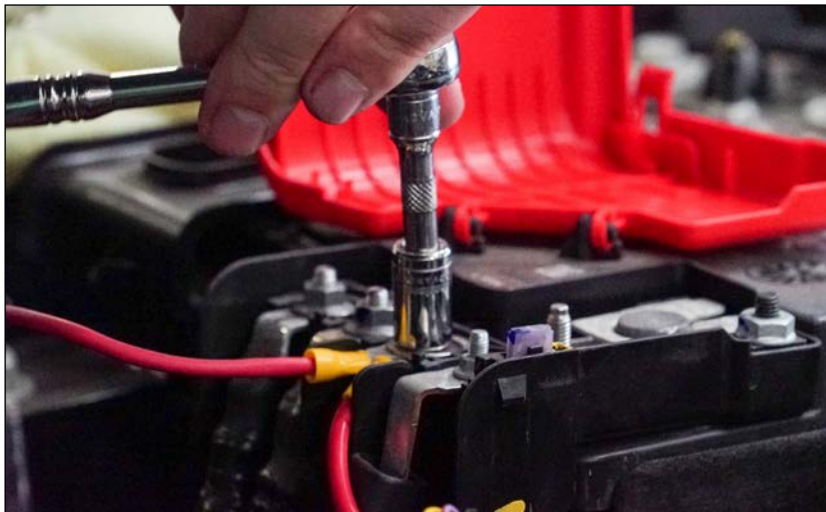

#### STEP 4

Connect 12v positive lead to the relay to one of the accessory power points on the battery.



#### STEP 5

Connect negative lead from relay to the chassis ground point.



#### STEP 6

Re-connect the battery, test the lights and tidy wiring.

#### IMPORTANT!

Keep the vehicle parked for a minimum of 24 hours after installation, so the pods have time to bond securely to the roof.